

7. [1 bonus point added to final grade] You have now finished the robotics course at UTSA. You have a job in a robotics company where you are tasked to create any robot of your choice. You have unlimited budget and manpower to do so.

(a) Describe what robot you will build in a **single sentence**.

(b) **Draw** the envisioned robot.

HINT: Be creative. For example, a futuristic robot or a robot that you think will solve a practical problem that you have encountered. In the space below, write the sentence followed by the drawing. I will post this page after the exam, so do not identify yourself.

I would create an underwater ROV that could clean up litter from natural bodies of water.



7. [1 bonus point added to final grade] You have now finished the robotics course at UTSA. You have a job in a robotics company where you are tasked to create any robot of your choice. You have unlimited budget and manpower to do so.

(a) Describe what robot you will build in a **single sentence**.

(b) **Draw** the envisioned robot.

HINT: Be creative. For example, a futuristic robot or a robot that you think will solve a practical problem that you have encountered. In the space below, write the sentence followed by the drawing. I will post this page after the exam, so do not identify yourself.

I will build a robot that is capable of serving food to you while providing you a display of your favorite television show.

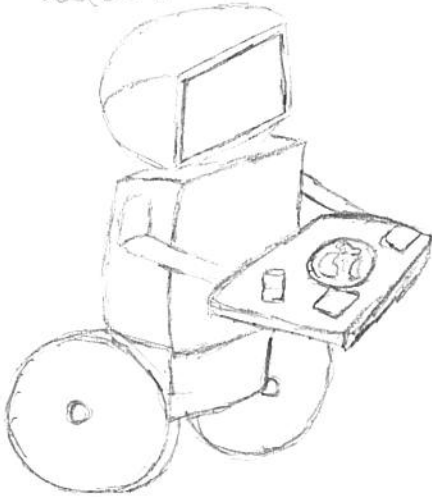

7. [1 bonus point added to final grade] You have now finished the robotics course at UTSA. You have a job in a robotics company where you are tasked to create any robot of your choice. You have unlimited budget and manpower to do so.

(a) Describe what robot you will build in a **single sentence**.

(b) **Draw** the envisioned robot.

HINT: Be creative. For example, a futuristic robot or a robot that you think will solve a practical problem that you have encountered. In the space below, write the sentence followed by the drawing. I will post this page after the exam, so do not identify yourself.

a) If I were to build a robot it would be able to transport me around the grocery store to get the items that I am shopping for.

b) Top View

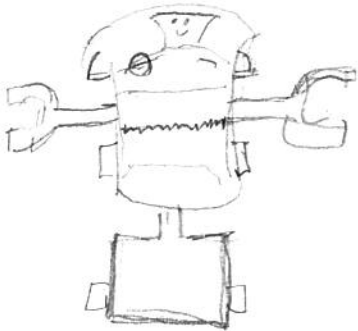

7. [1 bonus point added to final grade] You have now finished the robotics course at UTSA. You have a job in a robotics company where you are tasked to create any robot of your choice. You have unlimited budget and manpower to do so.

(a) Describe what robot you will build in a **single sentence**.

(b) **Draw** the envisioned robot.

HINT: Be creative. For example, a futuristic robot or a robot that you think will solve a practical problem that you have encountered. In the space below, write the sentence followed by the drawing. I will post this page after the exam, so do not identify yourself.

(a) I will build a (fly-Quad-Arm) manipulator

(b)

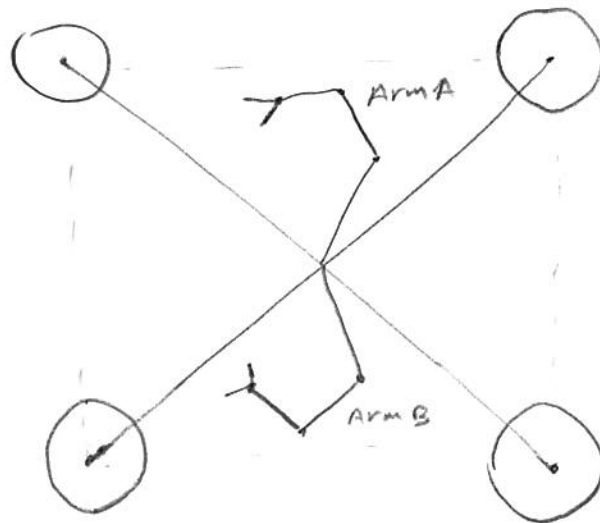

7. [1 bonus point added to final grade] You have now finished the robotics course at UTSA. You have a job in a robotics company where you are tasked to create any robot of your choice. You have unlimited budget and manpower to do so.

(a) Describe what robot you will build in a **single sentence**.

(b) **Draw** the envisioned robot.

HINT: Be creative. For example, a futuristic robot or a robot that you think will solve a practical problem that you have encountered. In the space below, write the sentence followed by the drawing. I will post this page after the exam, so do not identify yourself.

a) A robot that will be able to tend to sick people in the hospital when a nurse can't be with patients all the time. Dispense medication etc.

b) I can't draw so please don't post it.



7. [1 bonus point added to final grade] You have now finished the robotics course at UTSA. You have a job in a robotics company where you are tasked to create any robot of your choice. You have unlimited budget and manpower to do so.

(a) Describe what robot you will build in a **single sentence**.

(b) **Draw** the envisioned robot.

HINT: Be creative. For example, a futuristic robot or a robot that you think will solve a practical problem that you have encountered. In the space below, write the sentence followed by the drawing. I will post this page after the exam, so do not identify yourself.

A) A robot that can fold my clothes.

B) I'm a very bad drawer!

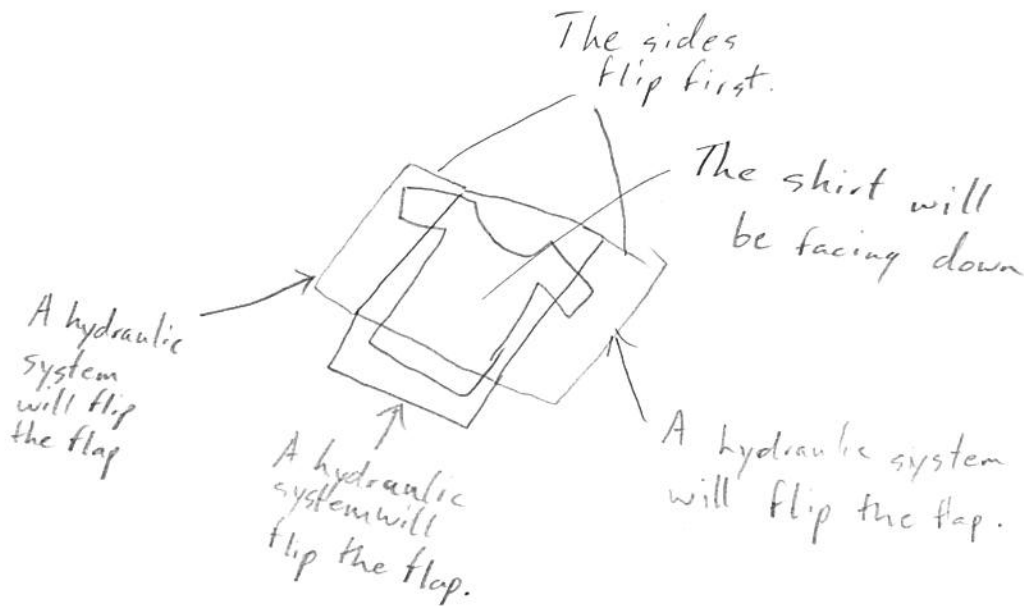

7. [1 bonus point added to final grade] You have now finished the robotics course at UTSA. You have a job in a robotics company where you are tasked to create any robot of your choice. You have unlimited budget and manpower to do so.

(a) Describe what robot you will build in a **single sentence**.

(b) **Draw** the envisioned robot.

HINT: Be creative. For example, a futuristic robot or a robot that you think will solve a practical problem that you have encountered. In the space below, write the sentence followed by the drawing. I will post this page after the exam, so do not identify yourself.

a) Valet Parking :-

flat Robot that can carry a car and park it automatically by using a sensors to detect any object around the robot.

Features :-

- 1- available anytime.
- 2- no labor needed.
- 3- It's useful in Airport or so.

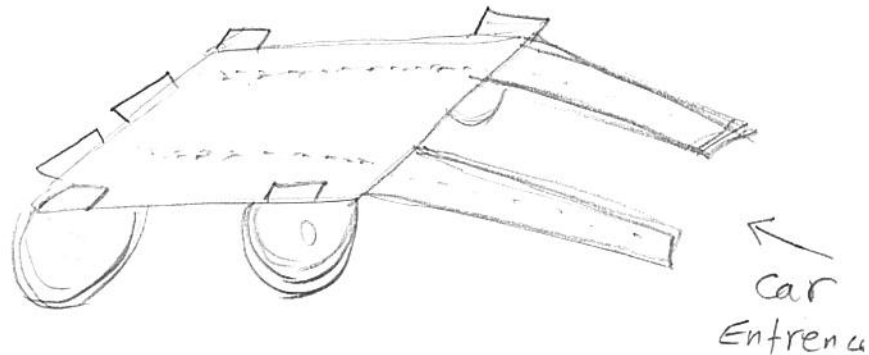

7. [1 bonus point added to final grade] You have now finished the robotics course at UTSA. You have a job in a robotics company where you are tasked to create any robot of your choice. You have unlimited budget and manpower to do so.

- (a) Describe what robot you will build in a **single sentence**.
- (b) **Draw** the envisioned robot.

HINT: Be creative. For example, a futuristic robot or a robot that you think will solve a practical problem that you have encountered. In the space below, write the sentence followed by the drawing. I will post this page after the exam, so do not identify yourself.

~~A robotic carrier that will transport ~~features~~
in and out of the warehouse at local spots.~~

An automatic @ robotic Carrier that will transport goods/products in and out of stock at a specific spot.

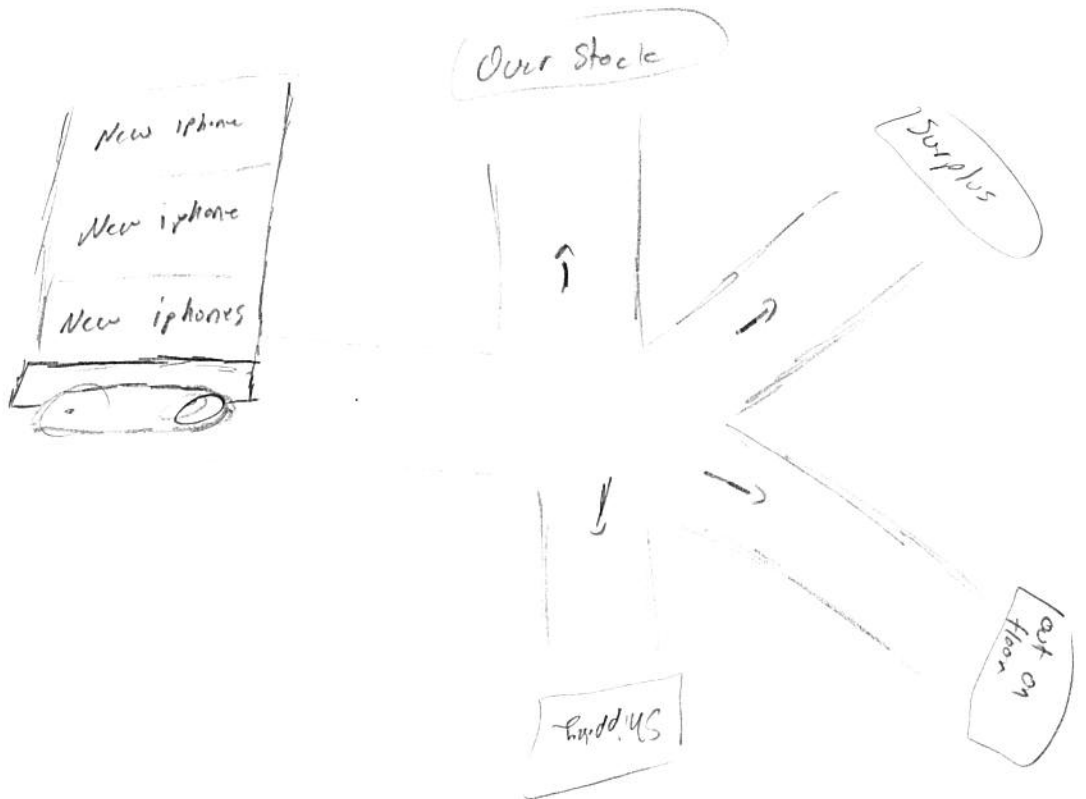

7. [1 bonus point added to final grade] You have now finished the robotics course at UTSA. You have a job in a robotics company where you are tasked to create any robot of your choice. You have unlimited budget and manpower to do so.

(a) Describe what robot you will build in a **single sentence**.

(b) **Draw** the envisioned robot.

HINT: Be creative. For example, a futuristic robot or a robot that you think will solve a practical problem that you have encountered. In the space below, write the sentence followed by the drawing. I will post this page after the exam, so do not identify yourself.

I would build a robot that could mine asteroids.

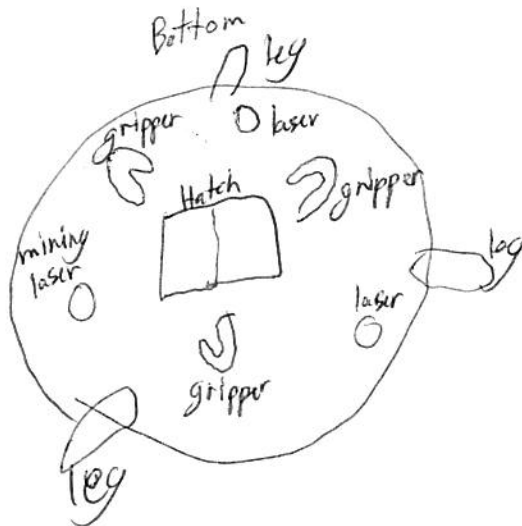

7. [1 bonus point added to final grade] You have now finished the robotics course at UTSA. You have a job in a robotics company where you are tasked to create any robot of your choice. You have unlimited budget and manpower to do so.

(a) Describe what robot you will build in a **single sentence**.

(b) **Draw** the envisioned robot.

HINT: Be creative. For example, a futuristic robot or a robot that you think will solve a practical problem that you have encountered. In the space below, write the sentence followed by the drawing. I will post this page after the exam, so do not identify yourself.

I would build an autonomous vehicle that could perform better than a human driver so that there would be a reason for everyone to get one, and when everyone has an autonomous vehicle, traffic jams and parking problems would largely become a thing of the past due to the capability of the vehicles to communicate almost instantaneously how they will move.

In order for people to be more accepting of the new technology, the first truly autonomous vehicles need to look as similar to a modern car as possible until the adjustment is made.

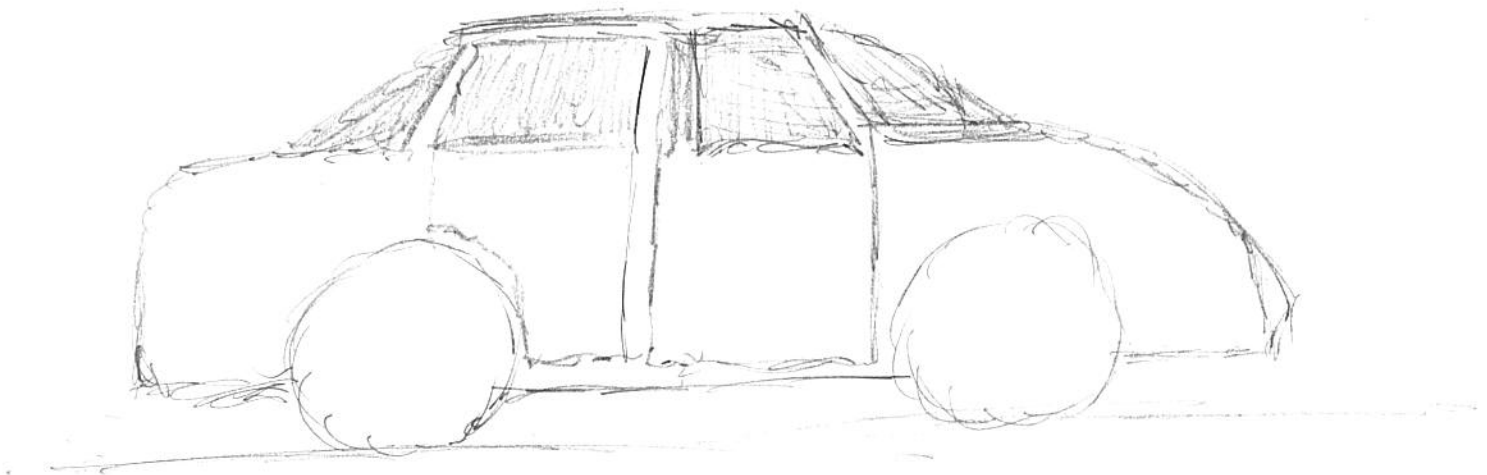

7. [1 bonus point added to final grade] You have now finished the robotics course at UTSA. You have a job in a robotics company where you are tasked to create any robot of your choice. You have unlimited budget and manpower to do so.

(a) Describe what robot you will build in a **single sentence**.

(b) **Draw** the envisioned robot.

HINT: Be creative. For example, a futuristic robot or a robot that you think will solve a practical problem that you have encountered. In the space below, write the sentence followed by the drawing. I will post this page after the exam, so do not identify yourself.

A mosquito bot to fight real mosquitos

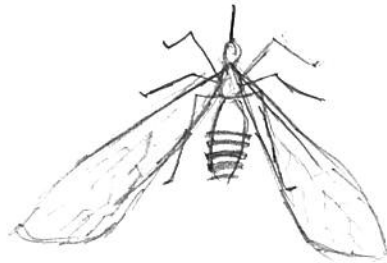

$$\dot{P}_0 = W_{0,i}^0 \times P_0 + R_0 \dot{P}_1 + 0^0$$

$$F_{att} = -\sum (P(0) - a) \text{ Parabolic}$$

$$U_{rep} = \begin{cases} \frac{1}{2} \left(\frac{1}{P(0)} - \frac{1}{P_0} \right)^2 & P(0) \leq P_0 \\ 0 & P(0) > P_0 \end{cases} \quad F_{rep} = \begin{cases} n_i \left(\frac{1}{P(0)} - \frac{1}{P_0} \right) \frac{1}{P^2(0)} \nabla P(0) & P(0) \leq P_0 \\ 0 & P(0) > P_0 \end{cases}$$

$$P(0) = \begin{pmatrix} 0 \\ \vdots \\ 0 \end{pmatrix}^T A_n^0$$

[1 bonus point added to final grade] You have now finished the robotics course at UTSA. You have a job in a robotics company where you are tasked to create any robot of your choice. You have unlimited budget and manpower to do so.

- (a) Describe what robot you will build in a **single sentence**.
- (b) **Draw** the envisioned robot.

HINT: Be creative. For example, a futuristic robot or a robot that you think will solve a practical problem that you have encountered. In the space below, write the sentence followed by the drawing. I will post this page after the exam, so do not identify yourself.

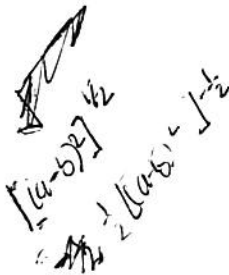

a) I would build a robot that would memorize all the formulas so that I did not need to.

b)

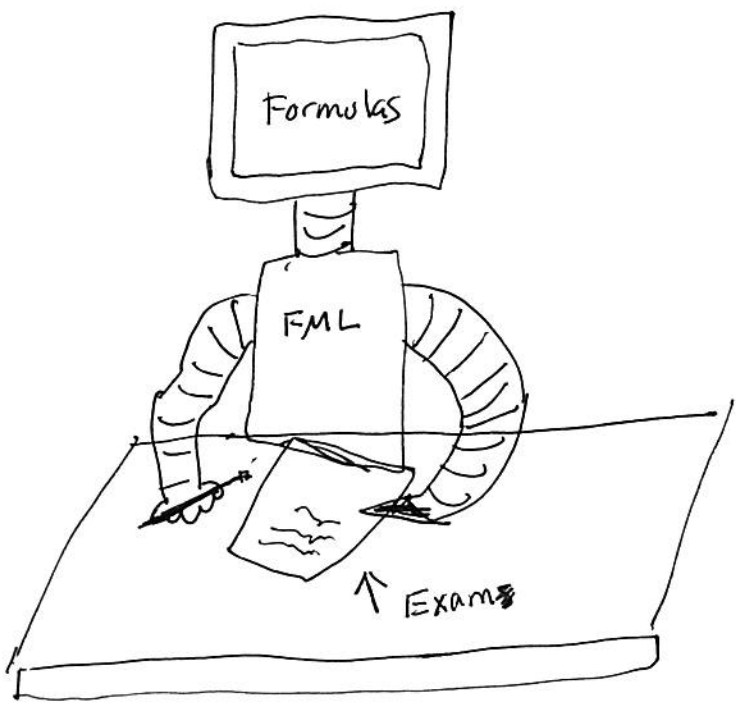

$$T = M(-k_p x - k_d \dot{x}) + c \dot{x} + G x$$

$$\ddot{x} + 2\zeta \omega_n \dot{x} + \omega_n^2 x = \frac{1}{M} T$$

$$M \ddot{x} + c \dot{x} + G x = T$$

$$\dot{x} = v \cos \theta = \frac{1}{2} (\dot{\theta}_r + \dot{\theta}_e) c \theta$$

$$\dot{y} = v \sin \theta = \frac{1}{2} (\dot{\theta}_r + \dot{\theta}_e) s \theta$$

$$\dot{\theta} = \omega = r \omega_n (\dot{\theta}_r - \dot{\theta}_e)$$

$$J = \begin{bmatrix} J_v \\ J_\omega \end{bmatrix} \quad J_{v1} = \begin{cases} R q_1 k \\ R q_1 k \\ 0 \end{cases} \quad \text{prismatic}$$

$$J_{\omega} = \begin{cases} R q_1 k \\ R q_1 k \\ 0 \end{cases} \quad \text{revolute}$$

$$P = \sum_{i=1}^n m_i g^T r_i \quad L = k - P \quad \text{potential}$$

$$K = \frac{1}{2} \dot{q}^T \left(\sum_{i=1}^n m_i J_{vi}^T J_{vi} + J_{\omega}^T R q_i F_i R q_i J_{\omega i} \right) \dot{q}$$

7. [1 bonus point added to final grade] You have now finished the robotics course at UTSA. You have a job in a robotics company where you are tasked to create any robot of your choice. You have unlimited budget and manpower to do so.

(a) Describe what robot you will build in a **single sentence**.

(b) **Draw** the envisioned robot.

HINT: Be creative. For example, a futuristic robot or a robot that you think will solve a practical problem that you have encountered. In the space below, write the sentence followed by the drawing. I will post this page after the exam, so do not identify yourself.

a.) I would want to build a robot that folds clothes.



7. [1 bonus point added to final grade] You have now finished the robotics course at UTSA. You have a job in a robotics company where you are tasked to create any robot of your choice. You have unlimited budget and manpower to do so.

(a) Describe what robot you will build in a **single sentence**.

(b) **Draw** the envisioned robot.

HINT: Be creative. For example, a futuristic robot or a robot that you think will solve a practical problem that you have encountered. In the space below, write the sentence followed by the drawing. I will post this page after the exam, so do not identify yourself.

(a) I will build a quadruped robot which would be able to traverse rough terrain similar to its biological counterparts while keeping the energy usage minimum.

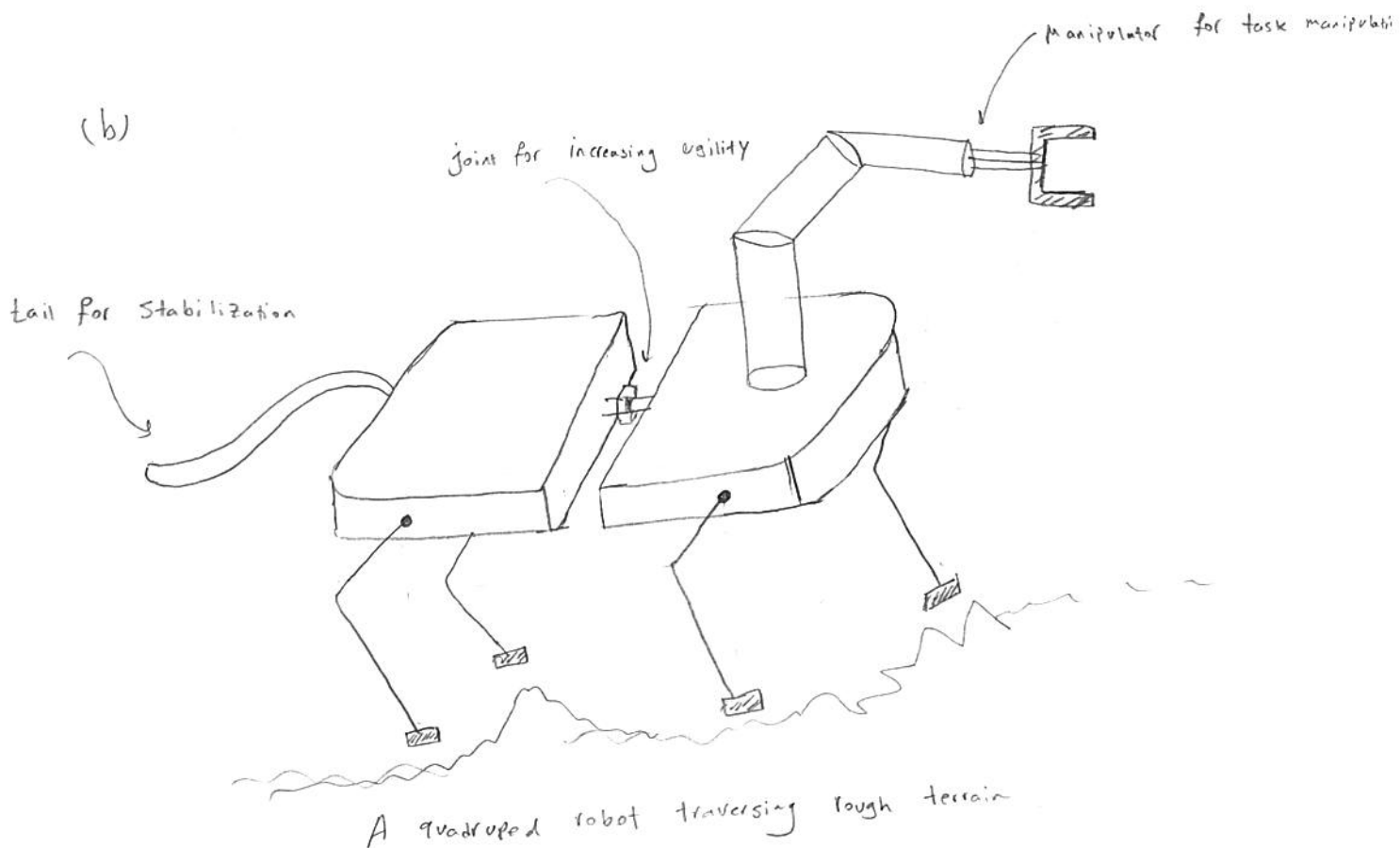

7. [1 bonus point added to final grade] You have now finished the robotics course at UTSA. You have a job in a robotics company where you are tasked to create any robot of your choice. You have unlimited budget and manpower to do so.

(a) Describe what robot you will build in a **single sentence**.

(b) **Draw** the envisioned robot.

HINT: Be creative. For example, a futuristic robot or a robot that you think will solve a practical problem that you have encountered. In the space below, write the sentence followed by the drawing. I will post this page after the exam, so do not identify yourself.

I would build a humanoid robot that could walk up stairs.

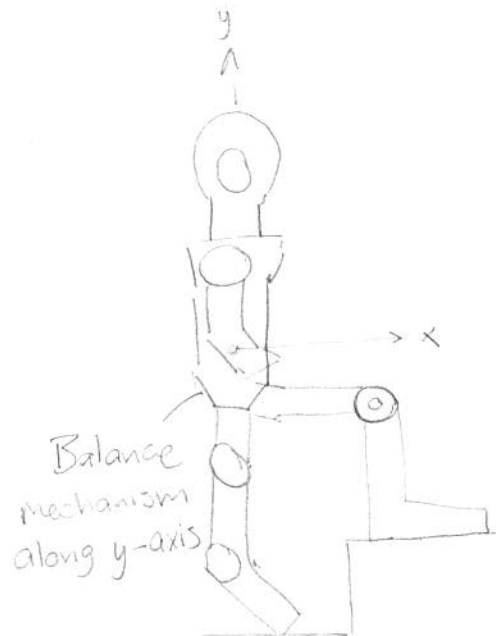

7. [1 bonus point added to final grade] You have now finished the robotics course at UTSA. You have a job in a robotics company where you are tasked to create any robot of your choice. You have unlimited budget and manpower to do so.

(a) Describe what robot you will build in a **single sentence**.

(b) **Draw** the envisioned robot.

HINT: Be creative. For example, a futuristic robot or a robot that you think will solve a practical problem that you have encountered. In the space below, write the sentence followed by the drawing. I will post this page after the exam, so do not identify yourself.

The robot I would build would be able to wash water bottles, and travel mugs for people on the go, like the hand washing stations at Rudy's.

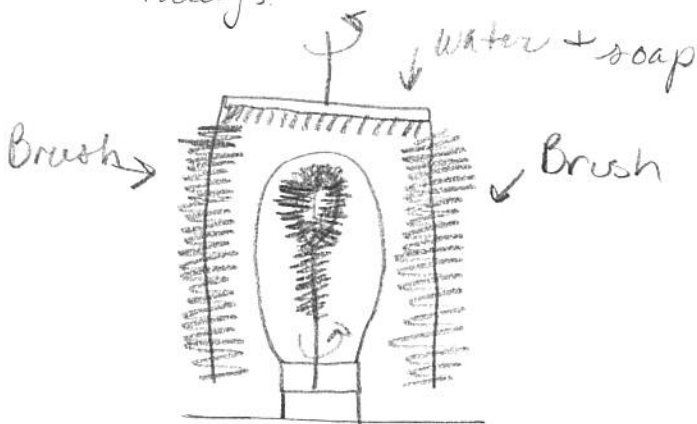

7. [1 bonus point added to final grade] You have now finished the robotics course at UTSA. You have a job in a robotics company where you are tasked to create any robot of your choice. You have unlimited budget and manpower to do so.

(a) Describe what robot you will build in a **single sentence**.

(b) **Draw** the envisioned robot.

HINT: Be creative. For example, a futuristic robot or a robot that you think will solve a practical problem that you have encountered. In the space below, write the sentence followed by the drawing. I will post this page after the exam, so do not identify yourself.

a)) I would Build a robot car that work with sensors and use it in the public without any driver.

B))

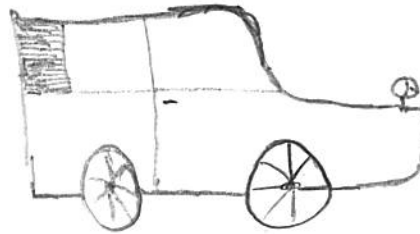

7. [1 bonus point added to final grade] You have now finished the robotics course at UTSA. You have a job in a robotics company where you are tasked to create any robot of your choice. You have unlimited budget and manpower to do so.

(a) Describe what robot you will build in a **single sentence**.

(b) **Draw** the envisioned robot.

HINT: Be creative. For example, a futuristic robot or a robot that you think will solve a practical problem that you have encountered. In the space below, write the sentence followed by the drawing. I will post this page after the exam, so do not identify yourself.

7a. I will build an autonomous solar sail robot to travel at relativistic velocities in order to collect data in the Alpha Centauri system and send it back to Earth.

7b.

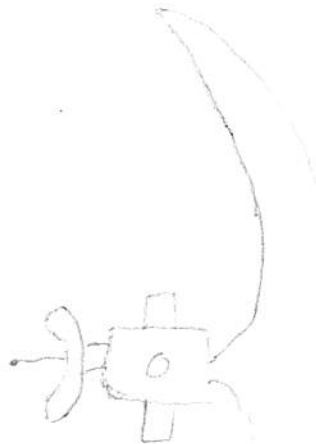

7. [1 bonus point added to final grade] You have now finished the robotics course at UTSA. You have a job in a robotics company where you are tasked to create any robot of your choice. You have unlimited budget and manpower to do so.

(a) Describe what robot you will build in a single sentence.

(b) Draw the envisioned robot.

HINT: Be creative. For example, a futuristic robot or a robot that you think will solve a practical problem that you have encountered. In the space below, write the sentence followed by the drawing. I will post this page after the exam, so do not identify yourself.

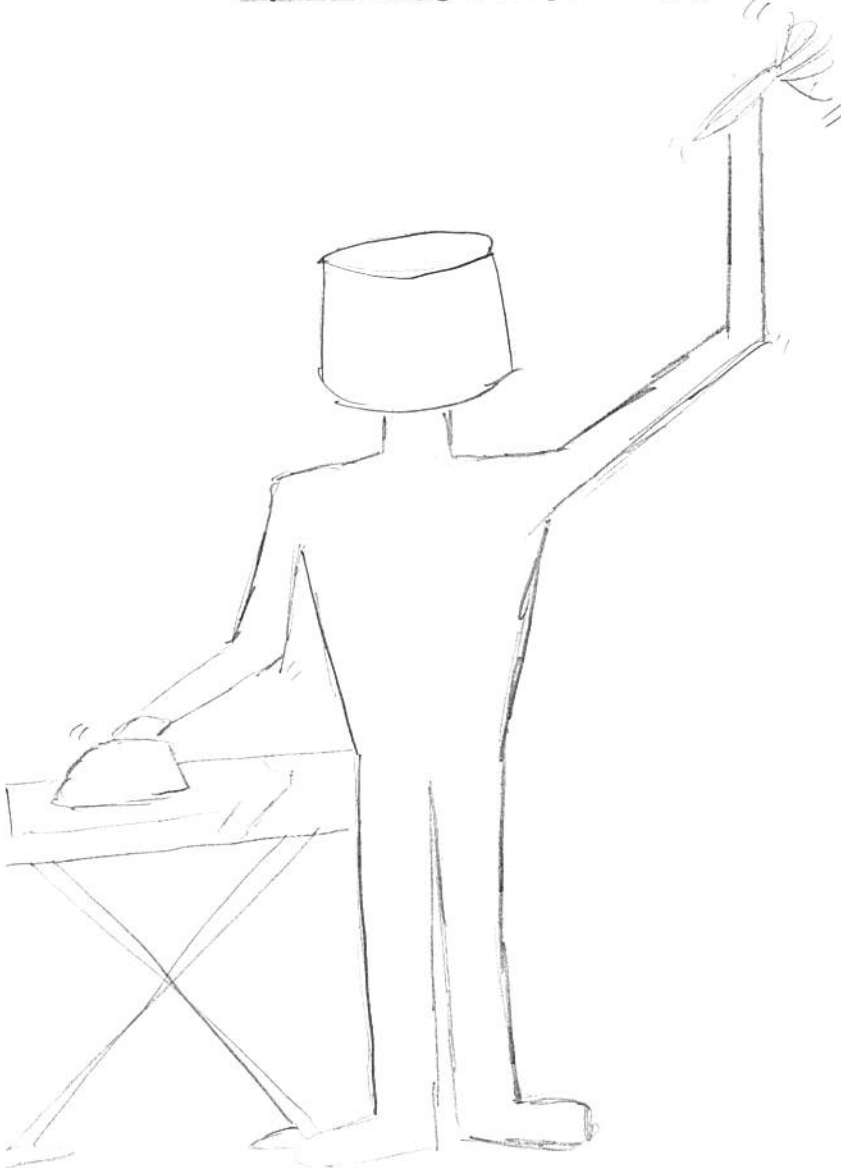

This robot does all household chores, from the laundry to dusting, from the dishes to mopping.

7. [1 bonus point added to final grade] You have now finished the robotics course at UTSA. You have a job in a robotics company where you are tasked to create any robot of your choice. You have unlimited budget and manpower to do so.

(a) Describe what robot you will build in a **single sentence**.

(b) **Draw** the envisioned robot.

HINT: Be creative. For example, a futuristic robot or a robot that you think will solve a practical problem that you have encountered. In the space below, write the sentence followed by the drawing. I will post this page after the exam, so do not identify yourself.

A tennis ball gathering and shooting robot.



7. [1 bonus point added to final grade] You have now finished the robotics course at UTSA. You have a job in a robotics company where you are tasked to create any robot of your choice. You have unlimited budget and manpower to do so.

(a) Describe what robot you will build in a **single sentence**.

(b) **Draw** the envisioned robot.

HINT: Be creative. For example, a futuristic robot or a robot that you think will solve a practical problem that you have encountered. In the space below, write the sentence followed by the drawing. I will post this page after the exam, so do not identify yourself.

I would build a robot that would be able to assist in search and rescue missions that would be able to function autonomously and should avoid collisions, and would be water proof

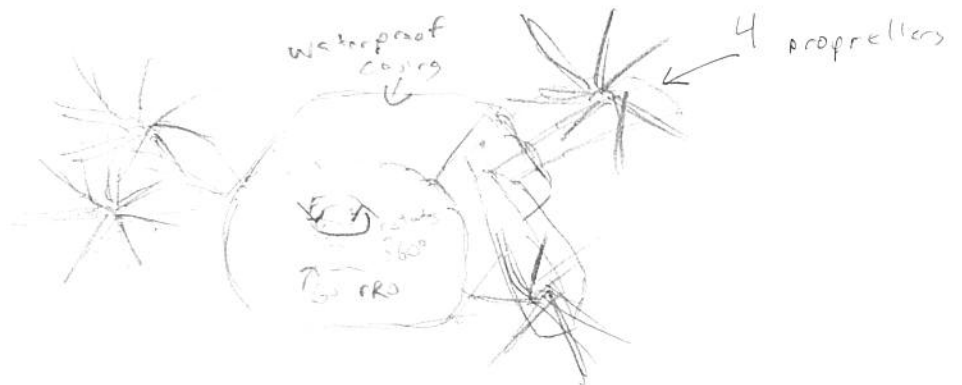

7. [1 bonus point added to final grade] You have now finished the robotics course at UTSA. You have a job in a robotics company where you are tasked to create any robot of your choice. You have unlimited budget and manpower to do so.

(a) Describe what robot you will build in a **single sentence**.

(b) **Draw** the envisioned robot.

HINT: Be creative. For example, a futuristic robot or a robot that you think will solve a practical problem that you have encountered. In the space below, write the sentence followed by the drawing. I will post this page after the exam, so do not identify yourself.

a) I will build a robot that can wipe tears away, particularly for VISA students who have just taken finals.

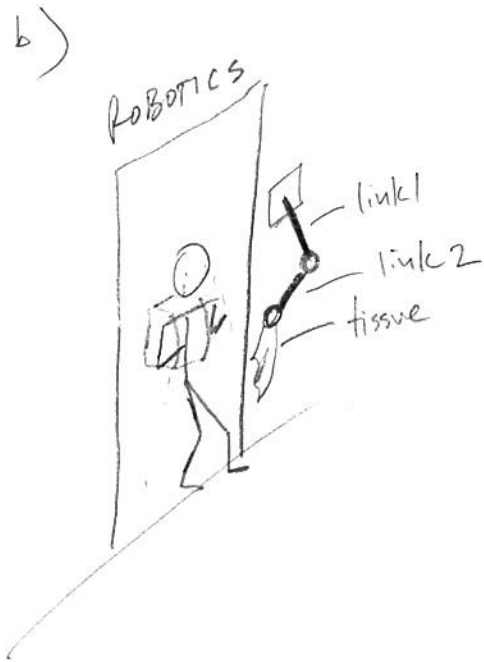

7. [1 bonus point added to final grade] You have now finished the robotics course at UTSA. You have a job in a robotics company where you are tasked to create any robot of your choice. You have unlimited budget and manpower to do so.

(a) Describe what robot you will build in a **single sentence**.

(b) **Draw** the envisioned robot.

HINT: Be creative. For example, a futuristic robot or a robot that you think will solve a practical problem that you have encountered. In the space below, write the sentence followed by the drawing. I will post this page after the exam, so do not identify yourself.

(a) Robot that can check tire pressure and can pump air into car tires.

(b)

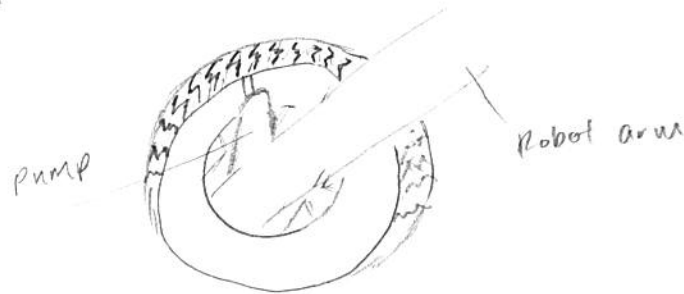

7. [1 bonus point added to final grade] You have now finished the robotics course at UTSA. You have a job in a robotics company where you are tasked to create any robot of your choice. You have unlimited budget and manpower to do so.

(a) Describe what robot you will build in a **single sentence**.

(b) **Draw** the envisioned robot.

HINT: Be creative. For example, a futuristic robot or a robot that you think will solve a practical problem that you have encountered. In the space below, write the sentence followed by the drawing. I will post this page after the exam, so do not identify yourself.

(a) Robot that can assist you find room in hotel

(b)

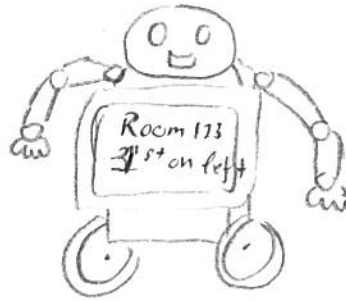

7. [1 bonus point added to final grade] You have now finished the robotics course at UTSA. You have a job in a robotics company where you are tasked to create any robot of your choice. You have unlimited budget and manpower to do so.

(a) Describe what robot you will build in a **single sentence**.

(b) **Draw** the envisioned robot.

HINT: Be creative. For example, a futuristic robot or a robot that you think will solve a practical problem that you have encountered. In the space below, write the sentence followed by the drawing. I will post this page after the exam, so do not identify yourself.

A robot that cuts the grass and trims the edges.



7. [1 bonus point added to final grade] You have now finished the robotics course at UTSA. You have a job in a robotics company where you are tasked to create any robot of your choice. You have unlimited budget and manpower to do so.

(a) Describe what robot you will build in a **single sentence**.

(b) **Draw** the envisioned robot.

HINT: Be creative. For example, a futuristic robot or a robot that you think will solve a practical problem that you have encountered. In the space below, write the sentence followed by the drawing. I will post this page after the exam, so do not identify yourself.

a) Robot to pick up and clean (after dogs)!
because a lot of people DO NOT CLEAN
after their dogs at parks.

b)

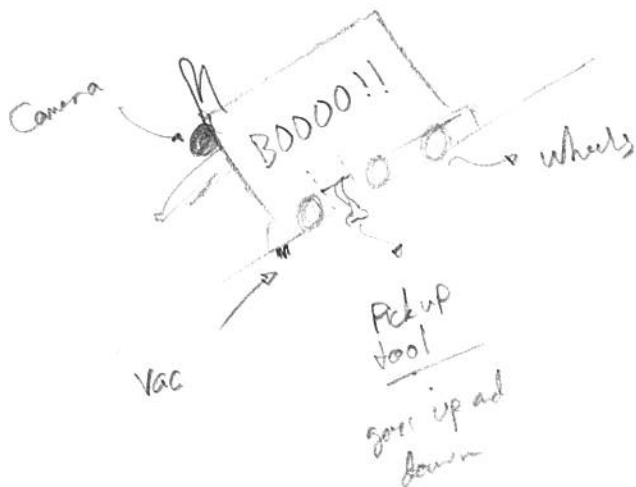

7. [1 bonus point added to final grade] You have now finished the robotics course at UTSA. You have a job in a robotics company where you are tasked to create any robot of your choice. You have unlimited budget and manpower to do so.

(a) Describe what robot you will build in a **single sentence**.

(b) **Draw** the envisioned robot.

HINT: Be creative. For example, a futuristic robot or a robot that you think will solve a practical problem that you have encountered. In the space below, write the sentence followed by the drawing. I will post this page after the exam, so do not identify yourself.

Homework Solving Robot

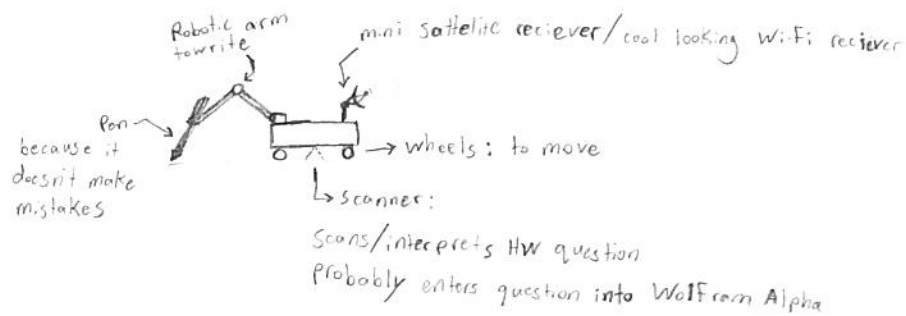

can also play with your cat for you:
replace pen with cat toy



7. [1 bonus point added to final grade] You have now finished the robotics course at UTSA. You have a job in a robotics company where you are tasked to create any robot of your choice. You have unlimited budget and manpower to do so.

(a) Describe what robot you will build in a **single sentence**.

(b) **Draw** the envisioned robot.

HINT: Be creative. For example, a futuristic robot or a robot that you think will solve a practical problem that you have encountered. In the space below, write the sentence followed by the drawing. I will post this page after the exam, so do not identify yourself.

I WOULD BUILD A SOFT ROBOT THAT HAS LOW STIFFNESS. THIS WOULD ALLOW IT TO ACCOMMODATE FOR CHANGES IN THE ENVIRONMENT! IT WOULD USE PNEUMATIC SOFT ACTUATION TO CREATE MOVEMENT BY EXPANDING AND CONTRACTING MOTION.

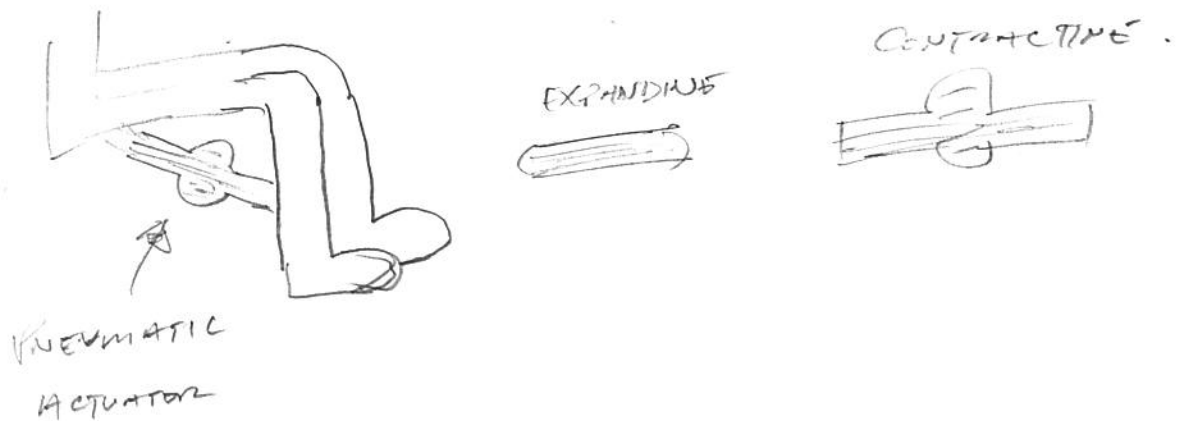

OR I WOULD MAKE A ROBOT THAT CAN SIMULATE THE MOVEMENT OF AN INVERTEBRATE. BASICALLY IT WOULD HAVE NO RIGID COMPONENTS INSIDE OF IT.



7. [1 bonus point added to final grade] You have now finished the robotics course at UTSA. You have a job in a robotics company where you are tasked to create any robot of your choice. You have unlimited budget and manpower to do so.

(a) Describe what robot you will build in a **single sentence**.

(b) **Draw** the envisioned robot.

HINT: Be creative. For example, a futuristic robot or a robot that you think will solve a practical problem that you have encountered. In the space below, write the sentence followed by the drawing. I will post this page after the exam, so do not identify yourself.

A robot that could monitor brainwave behavior and predict when a seizure will occur and send signals to counterreact the electrical "storm"

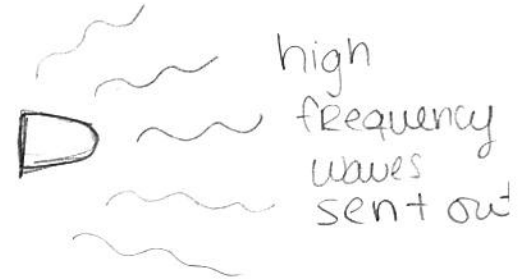
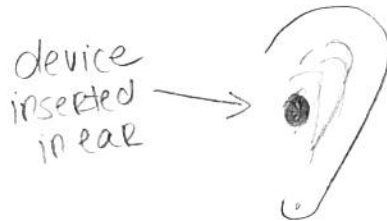

7. [1 bonus point added to final grade] You have now finished the robotics course at UTSA. You have a job in a robotics company where you are tasked to create any robot of your choice. You have unlimited budget and manpower to do so.

(a) Describe what robot you will build in a **single sentence**.

(b) **Draw** the envisioned robot.

HINT: Be creative. For example, a futuristic robot or a robot that you think will solve a practical problem that you have encountered. In the space below, write the sentence followed by the drawing. I will post this page after the exam, so do not identify yourself.

a) I would like to build an assistance arm that attach to the working desk.



7. [1 bonus point added to final grade] You have now finished the robotics course at UTSA. You have a job in a robotics company where you are tasked to create any robot of your choice. You have unlimited budget and manpower to do so.

(a) Describe what robot you will build in a **single sentence**.

(b) **Draw** the envisioned robot.

HINT: Be creative. For example, a futuristic robot or a robot that you think will solve a practical problem that you have encountered. In the space below, write the sentence followed by the drawing. I will post this page after the exam, so do not identify yourself.

I would design a robot that can do lawn scaping on its own.

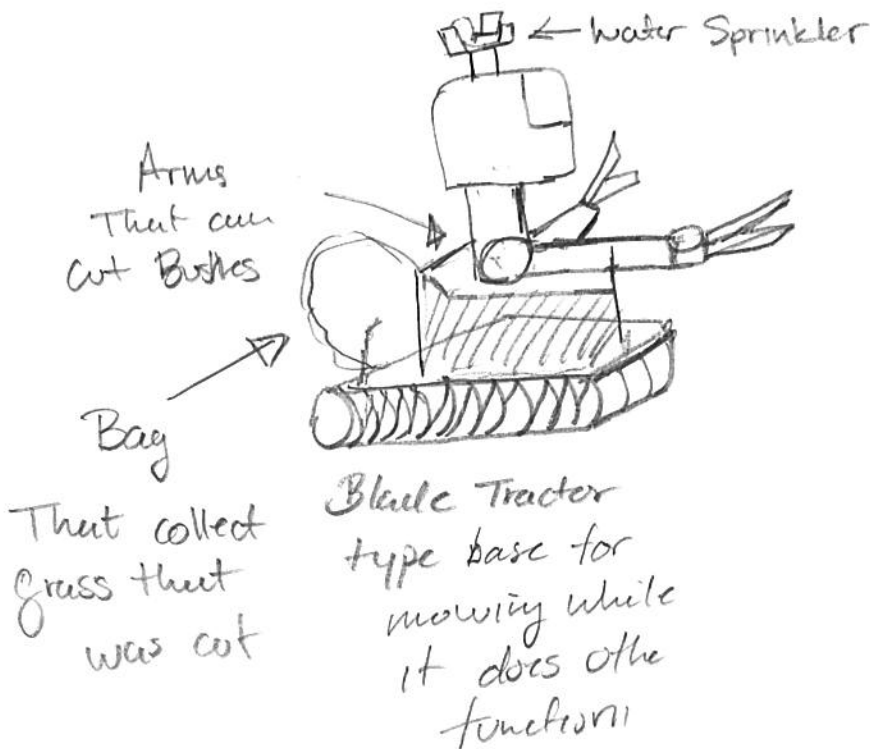

7. [1 bonus point added to final grade] You have now finished the robotics course at UTSA. You have a job in a robotics company where you are tasked to create any robot of your choice. You have unlimited budget and manpower to do so.

(a) Describe what robot you will build in a **single sentence**.

(b) **Draw** the envisioned robot.

HINT: Be creative. For example, a futuristic robot or a robot that you think will solve a practical problem that you have encountered. In the space below, write the sentence followed by the drawing. I will post this page after the exam, so do not identify yourself.

a) The robot I would build would be similar to a roomba but one that can mow your yard.

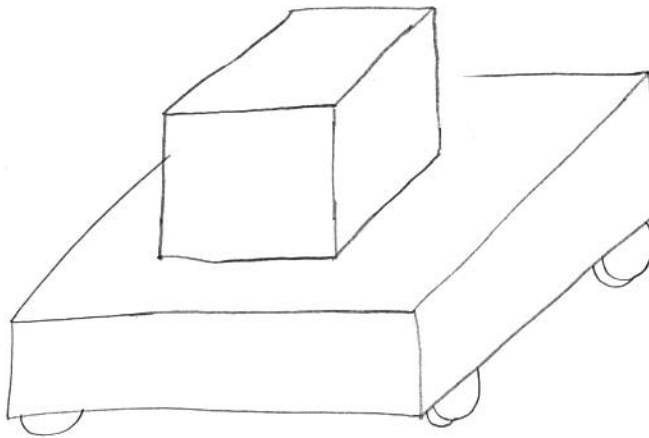

7. [1 bonus point added to final grade] You have now finished the robotics course at UTSA. You have a job in a robotics company where you are tasked to create any robot of your choice. You have unlimited budget and manpower to do so.

(a) Describe what robot you will build in a **single sentence**.

(b) **Draw** the envisioned robot.

HINT: Be creative. For example, a futuristic robot or a robot that you think will solve a practical problem that you have encountered. In the space below, write the sentence followed by the drawing. I will post this page after the exam, so do not identify yourself.

a) I would like my robot to guide me back to my vehicle at the end of the day...

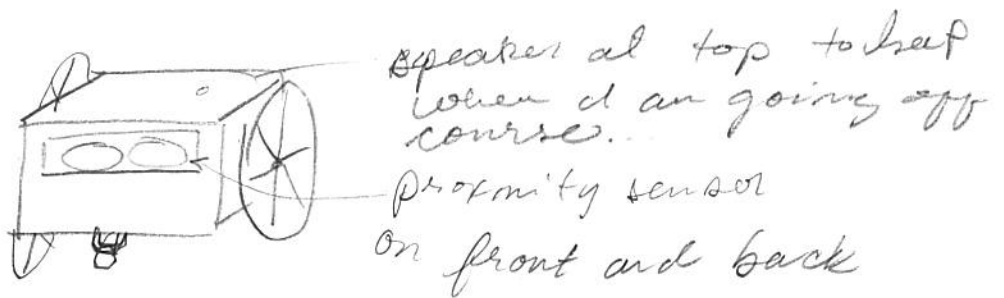

7. [1 bonus point added to final grade] You have now finished the robotics course at UTSA. You have a job in a robotics company where you are tasked to create any robot of your choice. You have unlimited budget and manpower to do so.

(a) Describe what robot you will build in a **single sentence**.

(b) **Draw** the envisioned robot.

HINT: Be creative. For example, a futuristic robot or a robot that you think will solve a practical problem that you have encountered. In the space below, write the sentence followed by the drawing. I will post this page after the exam, so do not identify yourself.

(a) I would design particle sized robots that could travel through the human body and detect if there are any health concerns or possible problems.

(b) Hard to draw A particle sized robot but ill try.

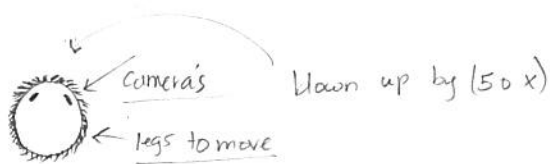

7. [1 bonus point added to final grade] You have now finished the robotics course at UTSA. You have a job in a robotics company where you are tasked to create any robot of your choice. You have unlimited budget and manpower to do so.

(a) Describe what robot you will build in a **single sentence**.

(b) **Draw** the envisioned robot.

HINT: Be creative. For example, a futuristic robot or a robot that you think will solve a practical problem that you have encountered. In the space below, write the sentence followed by the drawing. I will post this page after the exam, so do not identify yourself.

This Robot will slap
you if it detects
Procrastination.



7. [1 bonus point added to final grade] You have now finished the robotics course at UTSA. You have a job in a robotics company where you are tasked to create any robot of your choice. You have unlimited budget and manpower to do so.

(a) Describe what robot you will build in a **single sentence**.

(b) **Draw** the envisioned robot.

HINT: Be creative. For example, a futuristic robot or a robot that you think will solve a practical problem that you have encountered. In the space below, write the sentence followed by the drawing. I will post this page after the exam, so do not identify yourself.

a robot that turns human souls
into grilled-cheese sandwiches

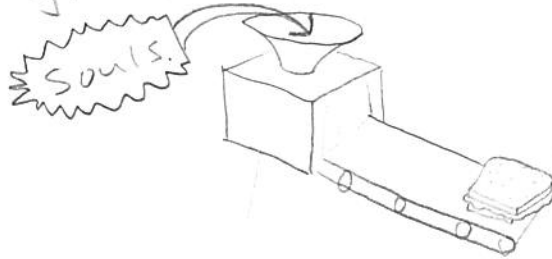

a robot that allows me to take
this question seriously

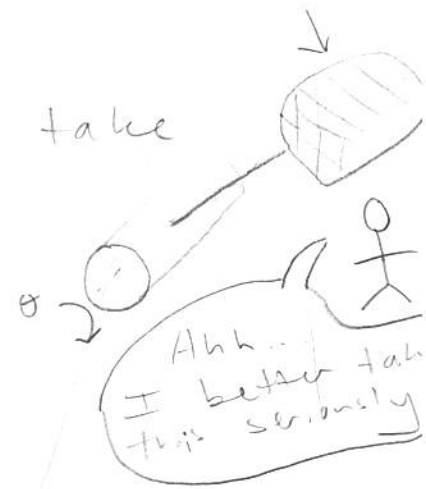

a robot that designs futuristic robots
for the last Robotics Final Exam Question
(but not evil sky net 'bots)

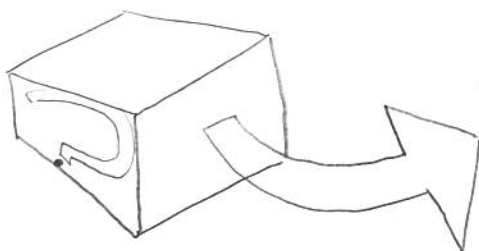

THE robot
idea that
everyone will
be jealous
of

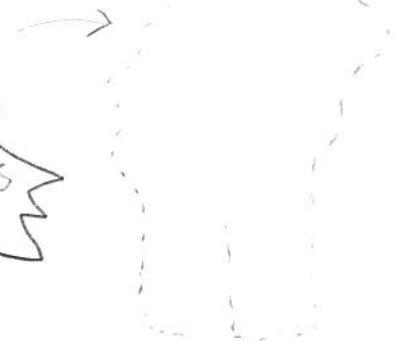

7. [1 bonus point added to final grade] You have now finished the robotics course at UTSA. You have a job in a robotics company where you are tasked to create any robot of your choice. You have unlimited budget and manpower to do so.

- (a) Describe what robot you will build in a **single sentence**.
- (b) **Draw** the envisioned robot.

HINT: Be creative. For example, a futuristic robot or a robot that you think will solve a practical problem that you have encountered. In the space below, write the sentence followed by the drawing. I will post this page after the exam, so do not identify yourself.

CONSTRUCT, A ROBOT THAT HAS THE ABILITY TO BUILD OR (3D Print) ON THE SURFACE OF MARS, BUT ALSO HAS THE MOBILITY TO MOVE TO ANY AREA ON ITS OWN

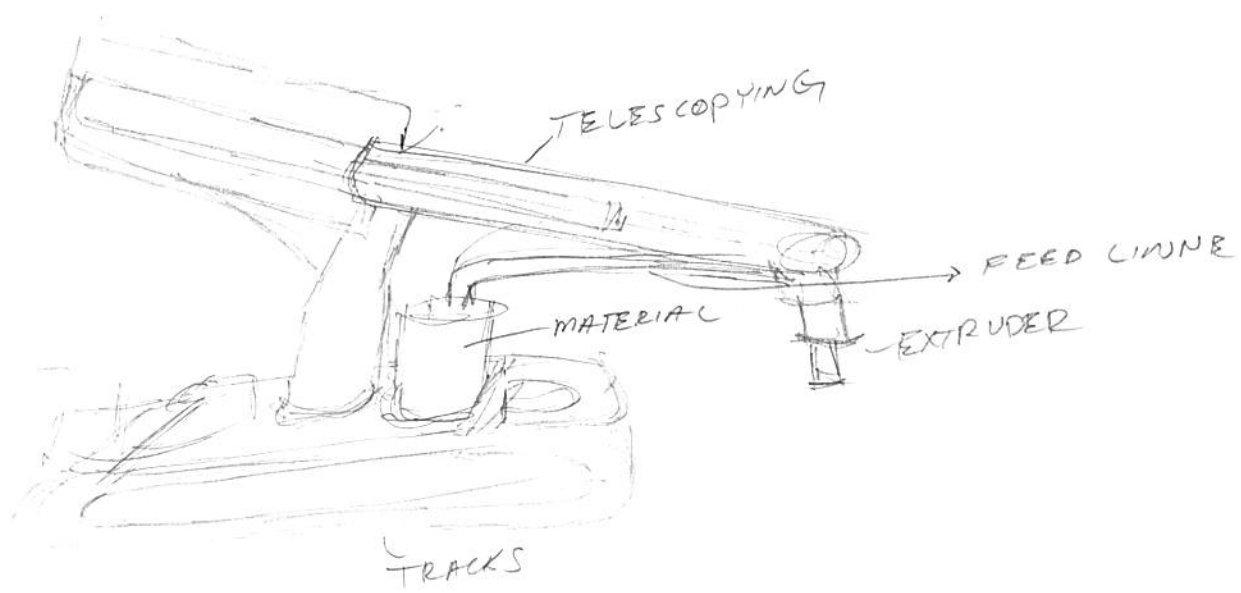

7. [1 bonus point added to final grade] You have now finished the robotics course at UTSA. You have a job in a robotics company where you are tasked to create any robot of your choice. You have unlimited budget and manpower to do so.

- (a) Describe what robot you will build in a **single sentence**.
- (b) **Draw** the envisioned robot.

HINT: Be creative. For example, a futuristic robot or a robot that you think will solve a practical problem that you have encountered. In the space below, write the sentence followed by the drawing. I will post this page after the exam, so do not identify yourself.

a) I would create a medical robot that would be able to perform simple tasks such as; stitches, administer shots, take blood, and others.

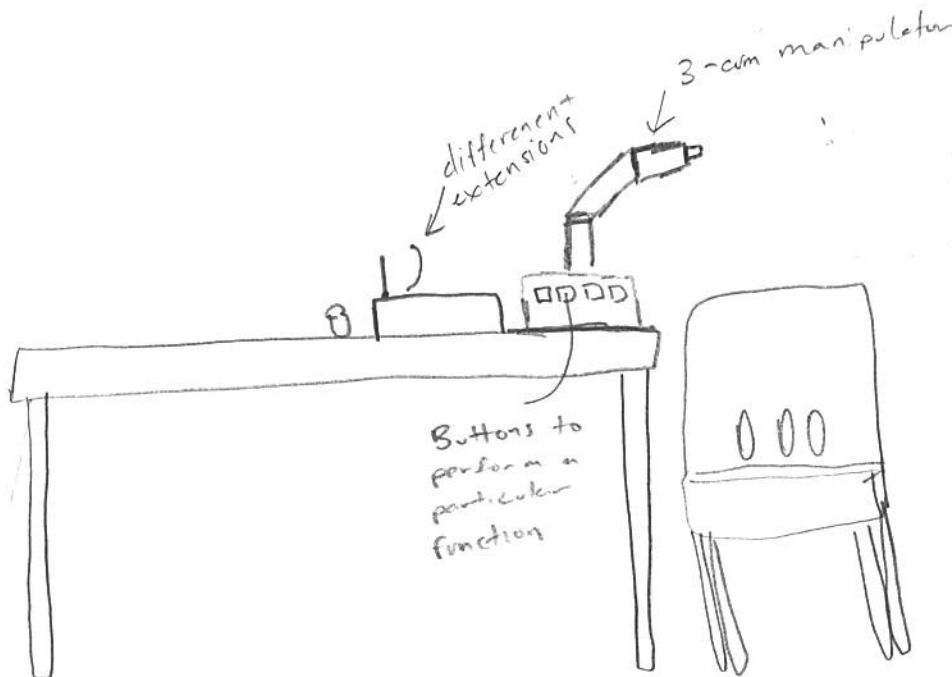

7. [1 bonus point added to final grade] You have now finished the robotics course at UTSA. You have a job in a robotics company where you are tasked to create any robot of your choice. You have unlimited budget and manpower to do so.

(a) Describe what robot you will build in a **single sentence**.

(b) **Draw** the envisioned robot.

HINT: Be creative. For example, a futuristic robot or a robot that you think will solve a practical problem that you have encountered. In the space below, write the sentence followed by the drawing. I will post this page after the exam, so do not identify yourself.

(a) Robot can bring my shoes.

(b)

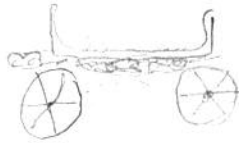

7. [1 bonus point added to final grade] You have now finished the robotics course at UTSA. You have a job in a robotics company where you are tasked to create any robot of your choice. You have unlimited budget and manpower to do so.

- (a) Describe what robot you will build in a **single sentence**.
- (b) **Draw** the envisioned robot.

HINT: Be creative. For example, a futuristic robot or a robot that you think will solve a practical problem that you have encountered. In the space below, write the sentence followed by the drawing. I will post this page after the exam, so do not identify yourself.

a) exoskeleton (To help people who can't walk or if they are missing a leg or arm.)

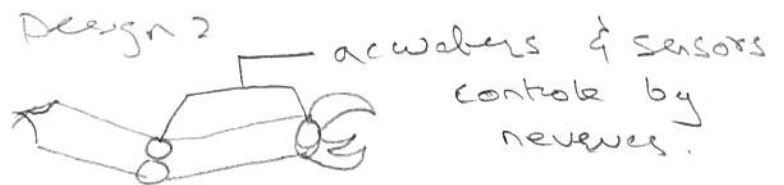
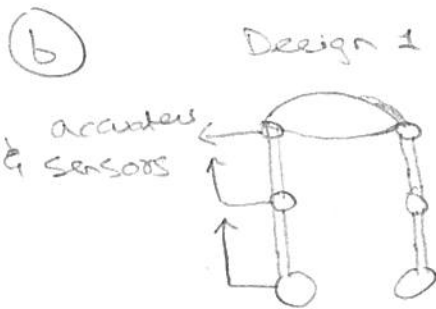

7. [1 bonus point added to final grade] You have now finished the robotics course at UTSA. You have a job in a robotics company where you are tasked to create any robot of your choice. You have unlimited budget and manpower to do so.

- (a) Describe what robot you will build in a **single sentence**.
- (b) **Draw** the envisioned robot.

HINT: Be creative. For example, a futuristic robot or a robot that you think will solve a practical problem that you have encountered. In the space below, write the sentence followed by the drawing. I will post this page after the exam, so do not identify yourself.

a) A robot that would be able to autonomously explore, catalog, and document the ocean floor and the terrain and creatures that reside there.

b)

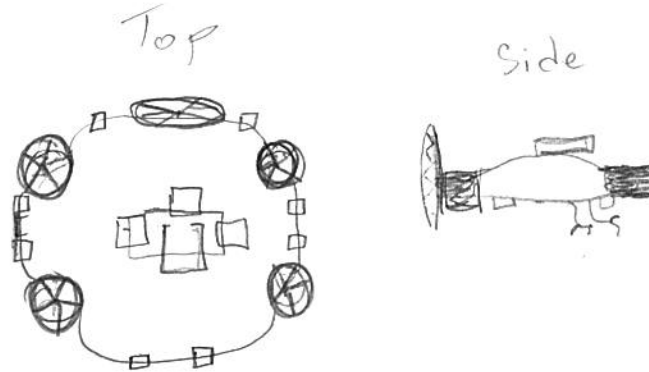

7. [1 bonus point added to final grade] You have now finished the robotics course at UTSA. You have a job in a robotics company where you are tasked to create any robot of your choice. You have unlimited budget and manpower to do so.

(a) Describe what robot you will build in a **single sentence**.

(b) **Draw** the envisioned robot.

HINT: Be creative. For example, a futuristic robot or a robot that you think will solve a practical problem that you have encountered. In the space below, write the sentence followed by the drawing. I will post this page after the exam, so do not identify yourself.

a) I would build a robot that would function as an autonomous car, reducing the number of accidents that occur on the road.

b)



Seats of drivers would remain in a relaxed position.

7. [1 bonus point added to final grade] You have now finished the robotics course at UTSA. You have a job in a robotics company where you are tasked to create any robot of your choice. You have unlimited budget and manpower to do so.

- (a) Describe what robot you will build in a **single sentence**.
- (b) **Draw** the envisioned robot.

HINT: Be creative. For example, a futuristic robot or a robot that you think will solve a practical problem that you have encountered. In the space below, write the sentence followed by the drawing. I will post this page after the exam, so do not identify yourself.

A Robot that measures reaction forces of a tire from a rolling road surface.

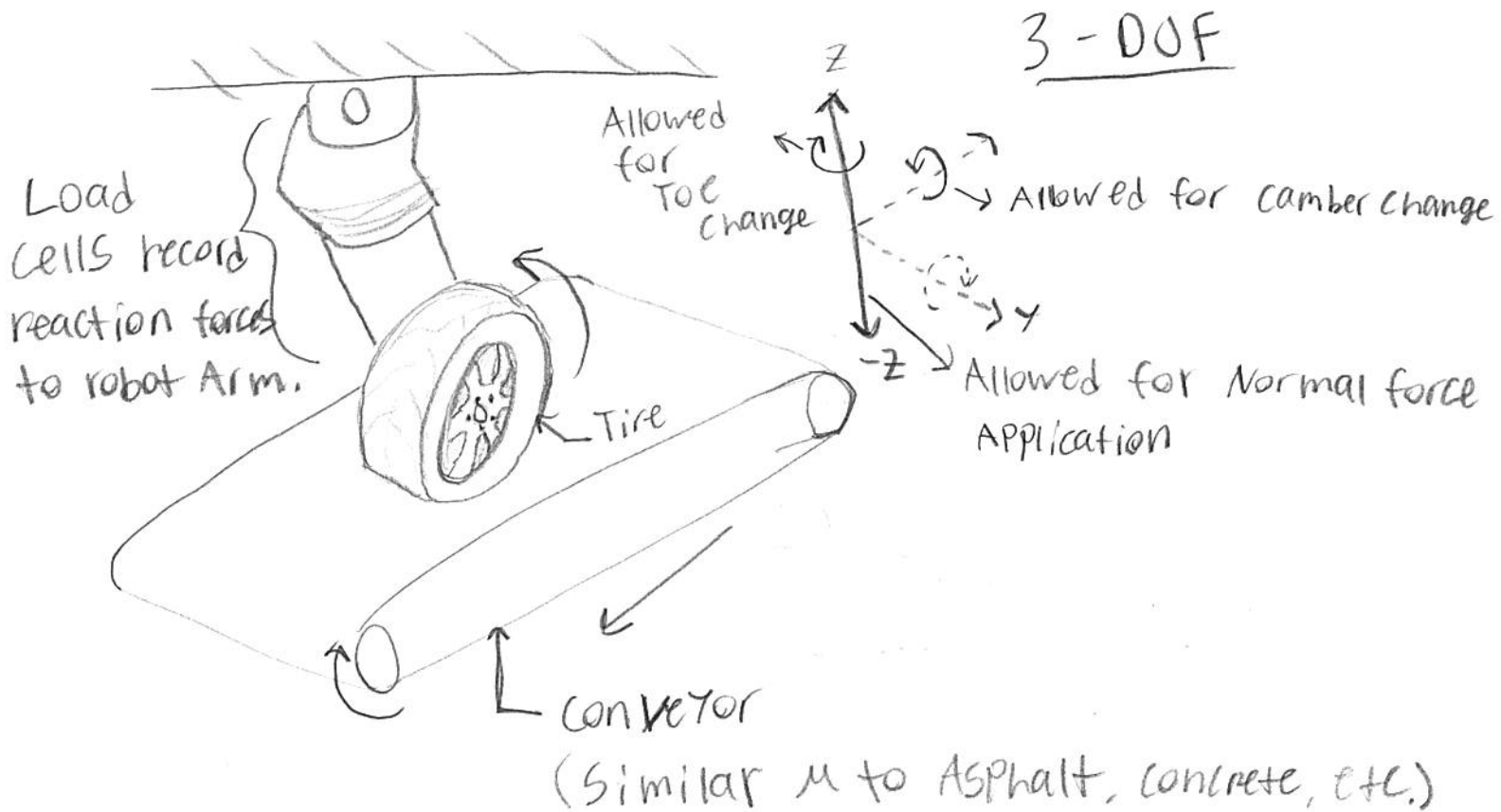

7. [1 bonus point added to final grade] You have now finished the robotics course at UTSA. You have a job in a robotics company where you are tasked to create any robot of your choice. You have unlimited budget and manpower to do so.

(a) Describe what robot you will build in a **single sentence**.

(b) **Draw** the envisioned robot.

HINT: Be creative. For example, a futuristic robot or a robot that you think will solve a practical problem that you have encountered. In the space below, write the sentence followed by the drawing. I will post this page after the exam, so do not identify yourself.

The robot will be a gigantic solar farm which uses its' energy to efficiently manage a farming/ranching eco system.

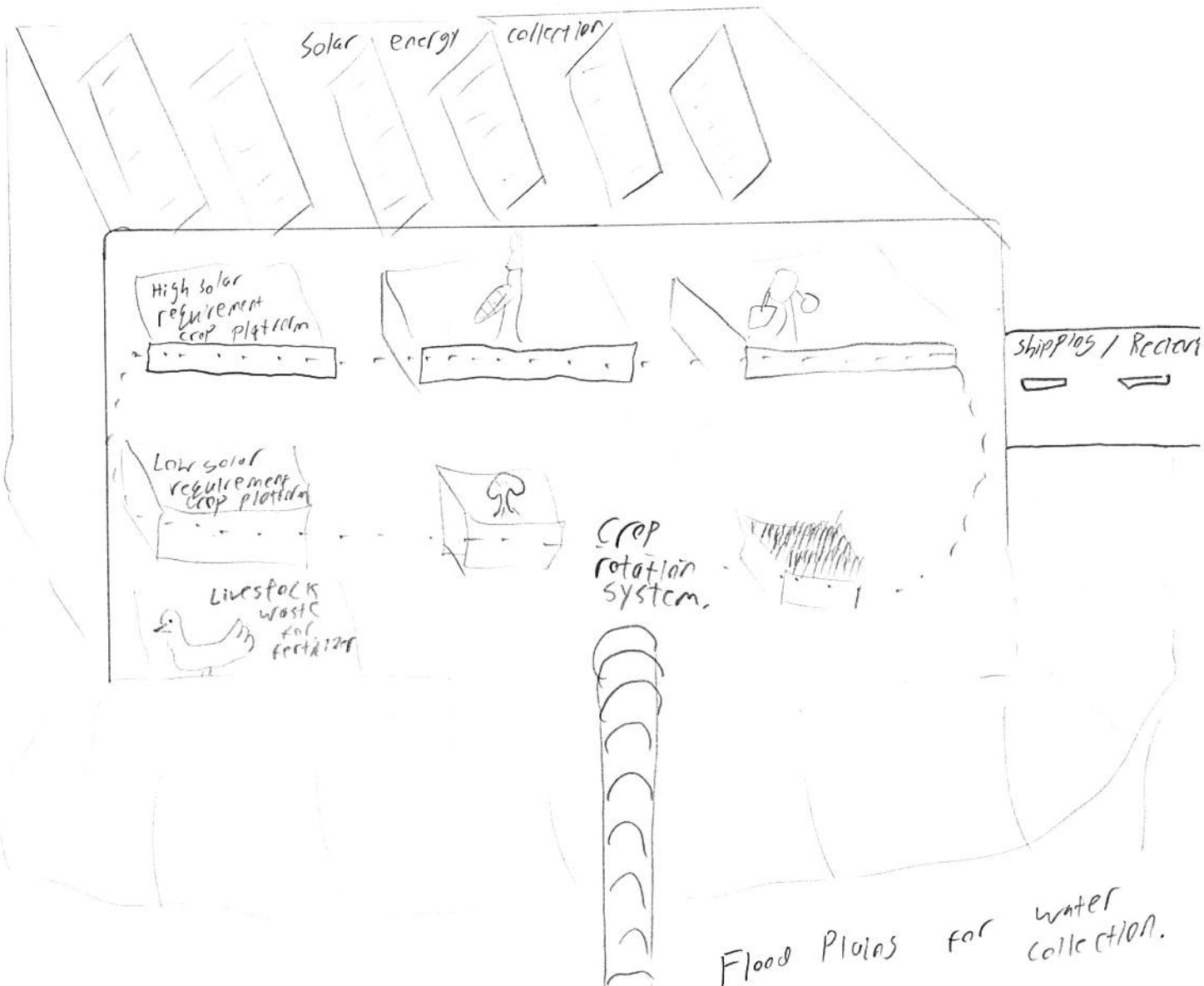

7. [1 bonus point added to final grade] You have now finished the robotics course at UTSA. You have a job in a robotics company where you are tasked to create any robot of your choice. You have unlimited budget and manpower to do so.

- (a) Describe what robot you will build in a **single sentence**.
- (b) **Draw** the envisioned robot.

HINT: Be creative. For example, a futuristic robot or a robot that you think will solve a practical problem that you have encountered. In the space below, write the sentence followed by the drawing. I will post this page after the exam, so do not identify yourself.

The walking Battle suit from Avatar (the James Cameron one).
Not Autonomous, but still cool.

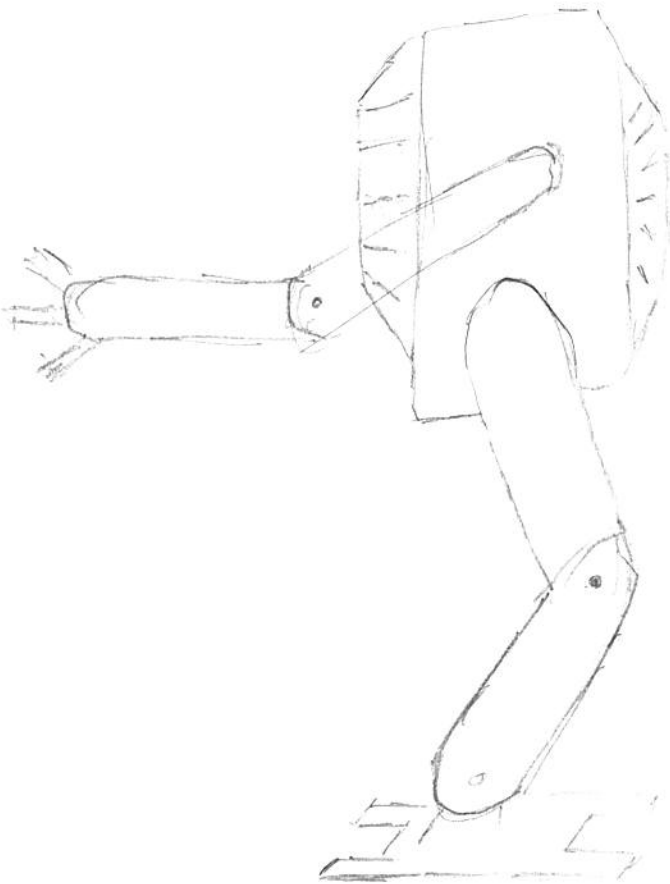

7. [1 bonus point added to final grade] You have now finished the robotics course at UTSA. You have a job in a robotics company where you are tasked to create any robot of your choice. You have unlimited budget and manpower to do so.

- (a) Describe what robot you will build in a **single sentence**.
- (b) **Draw** the envisioned robot.

HINT: Be creative. For example, a futuristic robot or a robot that you think will solve a practical problem that you have encountered. In the space below, write the sentence followed by the drawing. I will post this page after the exam, so do not identify yourself.

a) I would build a robot that can walk with elderly people and the same time be able to turn into a chair when they needed one.

b) Walking Robot

Robot turns into chair

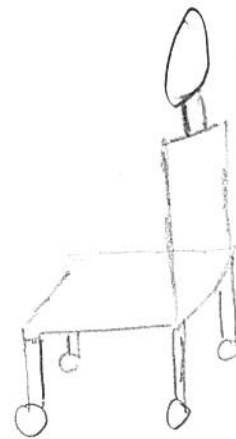
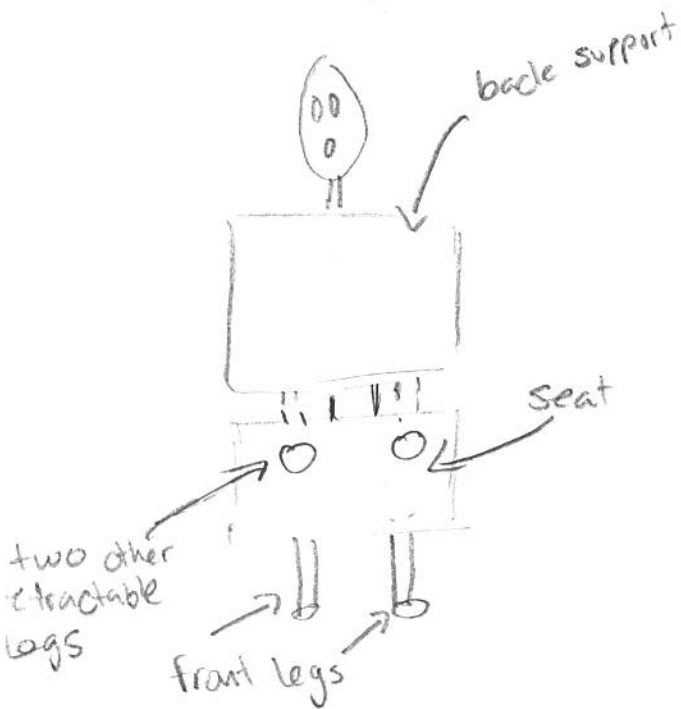

"side view"

7. [1 bonus point added to final grade] You have now finished the robotics course at UTSA. You have a job in a robotics company where you are tasked to create any robot of your choice. You have unlimited budget and manpower to do so.

(a) Describe what robot you will build in a **single sentence**.

(b) **Draw** the envisioned robot.

HINT: Be creative. For example, a futuristic robot or a robot that you think will solve a practical problem that you have encountered. In the space below, write the sentence followed by the drawing. I will post this page after the exam, so do not identify yourself.

a) I would make a robot ^{device} that would turn the page of a book.

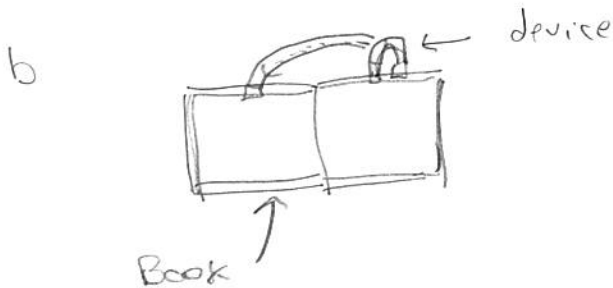

7. [1 bonus point added to final grade] You have now finished the robotics course at UTSA. You have a job in a robotics company where you are tasked to create any robot of your choice. You have unlimited budget and manpower to do so.

(a) Describe what robot you will build in a **single sentence**.

(b) **Draw** the envisioned robot.

HINT: Be creative. For example, a futuristic robot or a robot that you think will solve a practical problem that you have encountered. In the space below, write the sentence followed by the drawing. I will post this page after the exam, so do not identify yourself.

my robot would replace the kitchen, stock it with ingredients, select a meal, and enjoy dinner with no work input

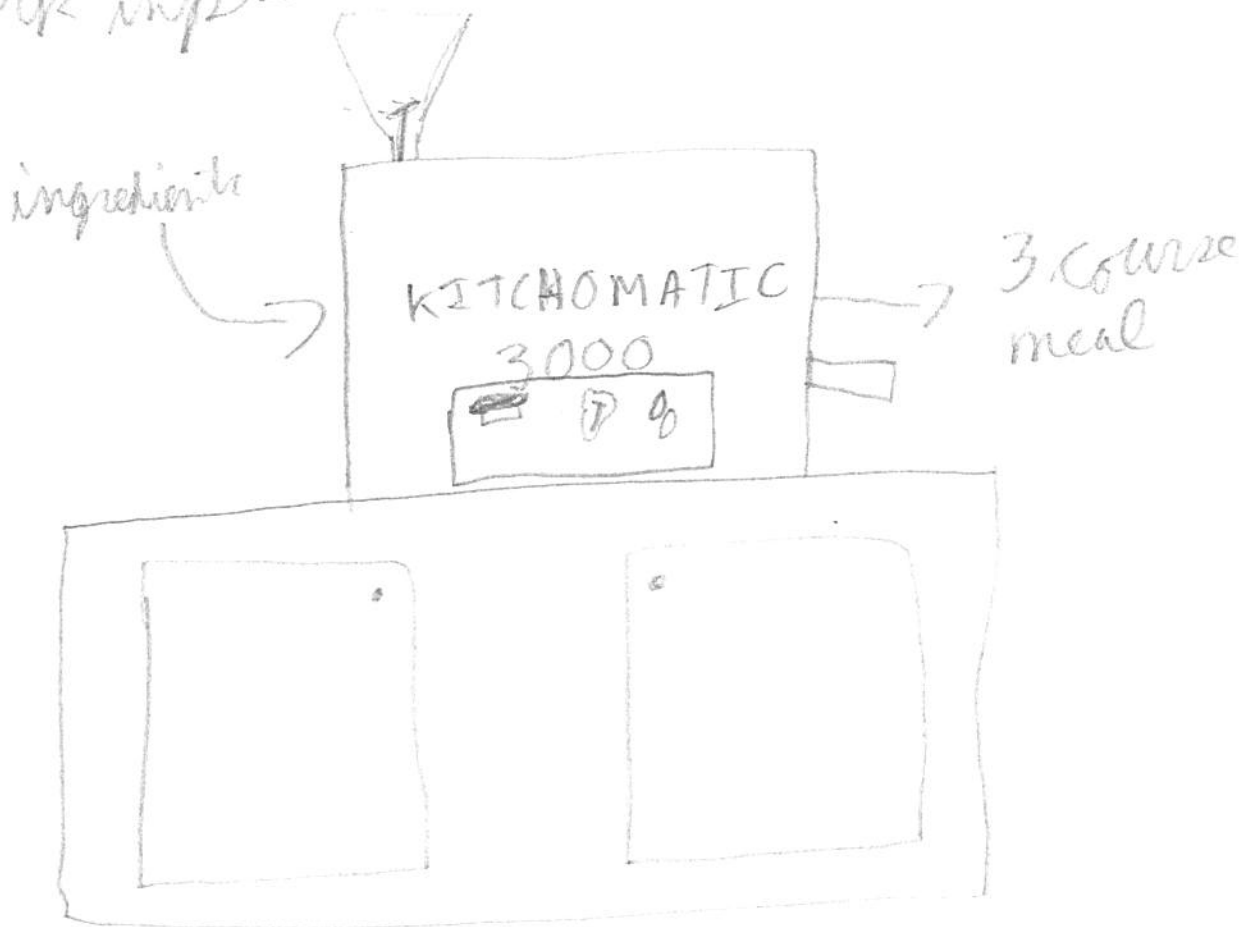

7. [1 bonus point added to final grade] You have now finished the robotics course at UTSA. You have a job in a robotics company where you are tasked to create any robot of your choice. You have unlimited budget and manpower to do so.

- (a) Describe what robot you will build in a **single sentence**.
- (b) **Draw** the envisioned robot.

HINT: Be creative. For example, a futuristic robot or a robot that you think will solve a practical problem that you have encountered. In the space below, write the sentence followed by the drawing. I will post this page after the exam, so do not identify yourself.

I would create a sentry robot which would work with police, fire, medical, and national defense personnel in times of crisis.



7. [1 bonus point added to final grade] You have now finished the robotics course at UTSA. You have a job in a robotics company where you are tasked to create any robot of your choice. You have unlimited budget and manpower to do so.

(a) Describe what robot you will build in a **single sentence**.

(b) **Draw** the envisioned robot.

HINT: Be creative. For example, a futuristic robot or a robot that you think will solve a practical problem that you have encountered. In the space below, write the sentence followed by the drawing. I will post this page after the exam, so do not identify yourself.



nano bot that joins together

with other bots to

complete any necessary task.

primary uses include medical +
manufacturing at the
nano scale

7. [1 bonus point added to final grade] You have now finished the robotics course at UTSA. You have a job in a robotics company where you are tasked to create any robot of your choice. You have unlimited budget and manpower to do so.

(a) Describe what robot you will build in a **single sentence**.

(b) **Draw** the envisioned robot.

HINT: Be creative. For example, a futuristic robot or a robot that you think will solve a practical problem that you have encountered. In the space below, write the sentence followed by the drawing. I will post this page after the exam, so do not identify yourself.

I would build a robot that takes advantage of the standard trash bins and maintain yard work via mowing, weed eating, and bagging of leaves

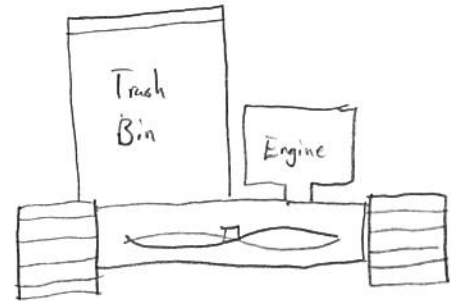
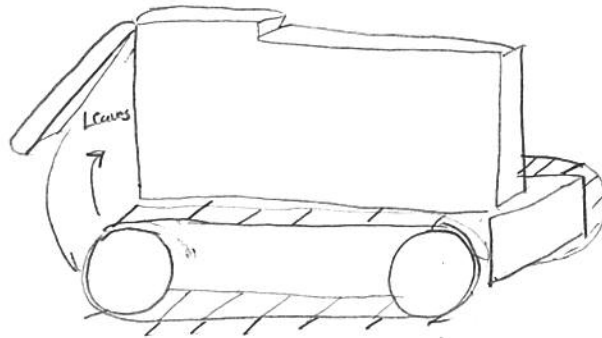

Standard bin size provides common outfit for people.